

CHURCHILL 36 Electric With Copper Pier Mount
(CH-36E CPM3)

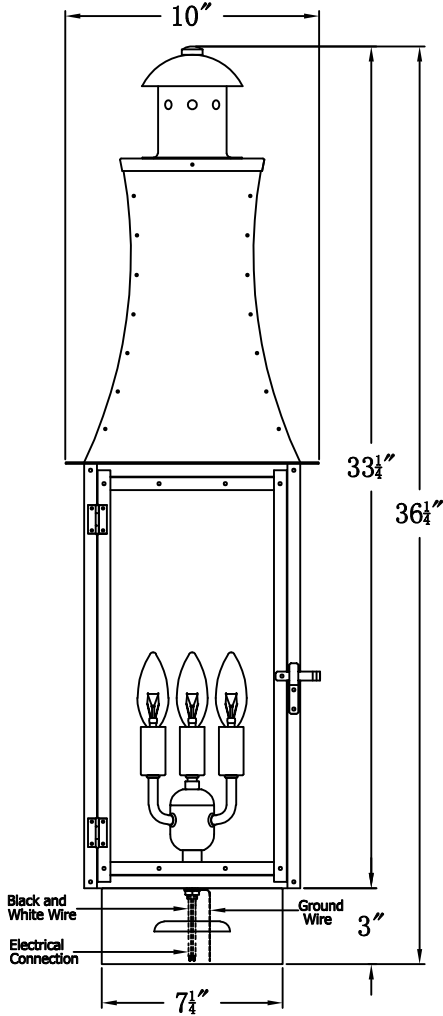

The CopperSmith		
Product Description	Drawing Description	9152 Hard Drive
Sockets:3-E12 Candelabra	REV:A/0	Foley Alabama 36536
Watts:3-60W	Date:02/26/2022	SKU Number:CH-36E
	Drawing by:Jason Huang	Product Name:Churchill 36 Electric