

CHURCHILL 38 Electric With Copper Pier Mount (CH-38E CPM3)

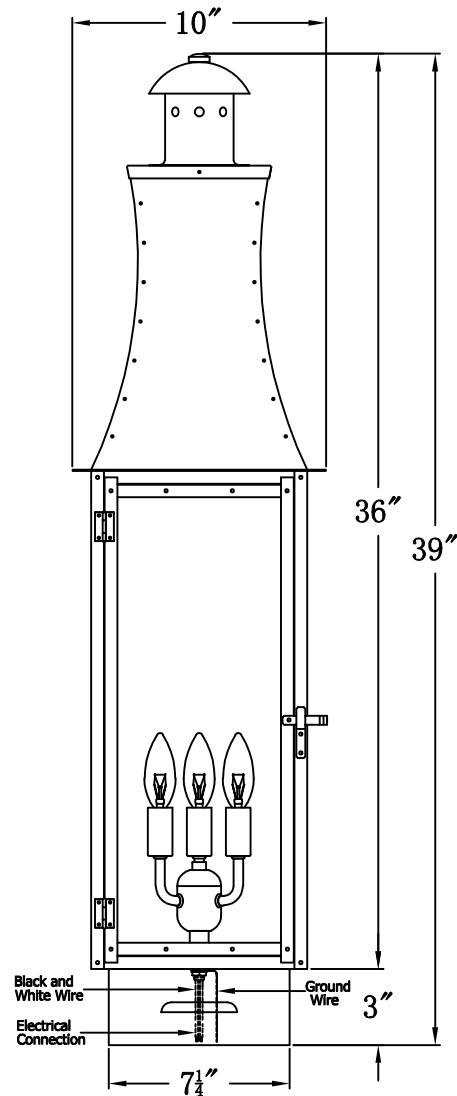

The CopperSmith

Product Description	Drawing Description	9152 Hard Drive
Sockets:3-E12 Candelabra	REV:A/0	Foley Alabama 36536
Watts:3-60W	Date:02/28/2022	SKU Number:CH-38E
	Drawing by:Jason Huang	Product Name:Churchill 38 Electric